

P3500 Series Spare Parts Manual

WWW.PANTUM.COM

Pantum P3500 Series Monochrome Single Function Laser Printer







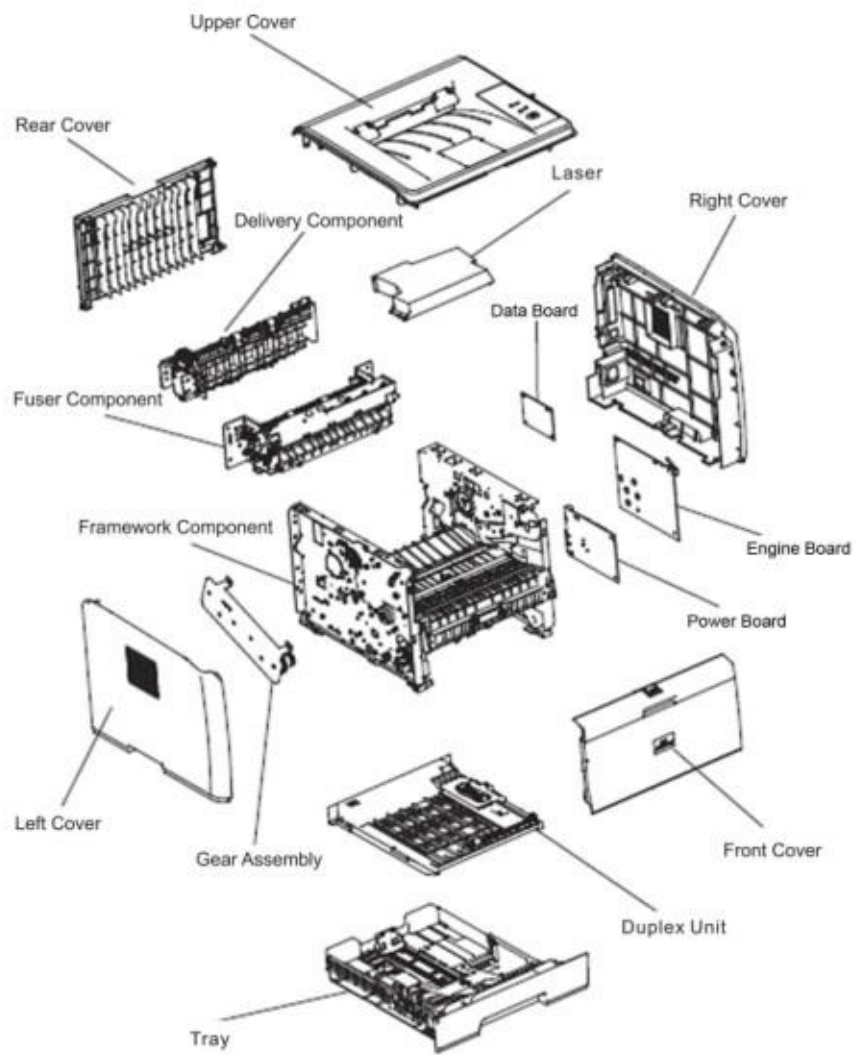



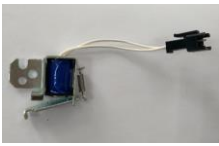

It is recommended to carefully read this Guide before using the printer

1 Components Summary

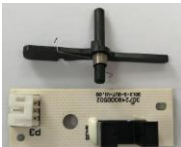



2 Paper feeder system

| The picture of Spare parts | The name of Spare parts | Faulty Phenomenon |
|-------------------------------------------------------------------------------------|-------------------------|--------------------------------------------------------------------------------------------------------------------------------------------------------------------------------------------------------------|
|  | Pick-up Assembly | <ul style="list-style-type: none"> ● Feed jam, paper light indicates red blinking. The monitor is shown feed jam |
|  | Separator Pad | <ul style="list-style-type: none"> ● Multipage feed ● Feed jam, paper light indicate red blinking ● The monitor is shown feed jam ● Paper jam after multipage feed |
|  | Paper Feed Solenoid | <ul style="list-style-type: none"> ● Feed jam, paper light indicate red blinking ● The monitor is shown feed jam ● Paper jam at the paper-feeding slot |
|  | Paper Feed Clutch | <ul style="list-style-type: none"> ● Feed Jam ● Paper jam at the paper-feeding slot |
|  | Paper feed Sensor | <ul style="list-style-type: none"> ● Feed Jam ● Paper Jam at the paper-feeding slot ● paper light indicate red blinking, The monitor is shown lack of paper or feed jam |
|  | Transfer Sensor | <ul style="list-style-type: none"> ● Paper jam in the middle, paper jam through the toner or sometimes the sound is abnormal ● paper light indicate red steady on |
|  | Paper Exit Sensor | <ul style="list-style-type: none"> ● Paper jam at the paper-feeding slot, and paper jam at the fuser unit ● Paper light indicate red steady on |



| | | |
|-----------------------------------------------------------------------------------|-----------------------------------------------|------------------------------------------------------------------------------------------------------------------------------------------------------------------------------|
|  | Double-sided Unit(Black, LTR) 301022171001 | <ul style="list-style-type: none"> ● Paper jam in the duplex printing ● Paper light indicate red steady on |
|  | Duplex Solenoid 301022173001 | <ul style="list-style-type: none"> ● Paper jam in duplex printing ● Duplex printing's reversal is abnormal |
|  | DC Main Motor 301022163001 | <ul style="list-style-type: none"> ● The gear is not rotating after power on. ● Paper feeding jam meanwhile by the roar ● Internal error 01 |

3 Control Component

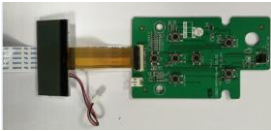

| The picture of Spare parts | The name of Spare parts | Faulty Phenomenon |
|-------------------------------------------------------------------------------------|---------------------------------------------------------------------------------------|------------------------------------------------------------------------------------------------------------------------------------------------------------------------------------------------------------------------------------------------------------------------------------------------------------------------------------------------------------------------------------------------------------------------------|
|  | Data Board-A (USB+NET+WIFI) 301022165001 Data Board-A (USB+NET) 301022166001 | <ul style="list-style-type: none"> ● USB connection is not recognized ● WIFI connection is abnormal. ● Toner is not recognized. ● Printing with gibberish and all black graphic ● Printing with blank paper ● The LCD screen is not shown. ● No power(no indicator lights) ● Internal error 11 ● Network is failure and disconnected. |
|  | Engine Board-A P3500DW 30102216500) | <ul style="list-style-type: none"> ● Internal error 01 ● Internal error 02-03 ● Internal error 04-10 ● Printing with all blank or all black ● It shown "front cover is open." ● Printer is not warming up and in the sleeping time all the time. |



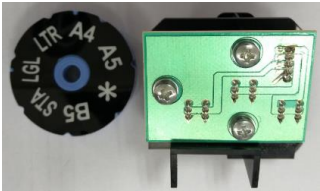

| | | |
|-----------------------------------------------------------------------------------|--------------------------------------|------------------------------------------------------------------------------------------------------------------------------------------------------------|
|  | Power Board-A (220V) 301022169001 | <ul style="list-style-type: none"> ● No power ● Internal error 04-10 ● It was shown “rear cover is open” |
| | Power Board-B (110V) 301022170001 | |
|  | Control Board -A 301022174001 | <ul style="list-style-type: none"> ● The LCD screen is not shown. ● The LCD screen is blank. ● The button is malfunction. |

4 Imaging Component

| The picture of Spare parts | The name of Spare parts | Faulty Phenomenon |
|-------------------------------------------------------------------------------------|------------------------------------------------------------------------|----------------------------------------------------------------------------------------------------------------------------------------------|
|  | Laser Scanning Unit 301022112001 | <ul style="list-style-type: none"> ● Internal error 02-03 ● Printing with blank ● Printing with blank lines |
|  | Transfer Roller 301020128001 | <ul style="list-style-type: none"> ● Printing pale |
|  | Fuser Unit (220V) 301022167001 Fuser Unit (110V) 301022168001 | <ul style="list-style-type: none"> ● Internal error 04-10 ● Paper jam ● Abnormal noise |

5 Additional tray Component

| The picture of Spare parts | The name of Spare parts | Faulty Phenomenon |
|-------------------------------------------------------------------------------------|-------------------------------------|-----------------------------------------------------------------------------------|
|  | Paper type selector 301022175001 | <ul style="list-style-type: none"> ● Feed jam |
|  | Paper Feeder Sensor | <ul style="list-style-type: none"> ● Feed jam ● Paper jam |

| | | |
|-----------------------------------------------------------------------------------|--------------------------------------------------------------------|-------------------------------------------------------------------------------------------------------------|
|  | <p>Paper Empty Flag</p> | <ul style="list-style-type: none"> ● Feed jam |
|  | <p>Pick-up Roller</p> | <ul style="list-style-type: none"> ● Feed jam |
|  | <p>Main Motor 301022163001</p> | <ul style="list-style-type: none"> ● Feed jam ● Abnormal noise. |
|  | <p>Control board of additional paper tray 301022177001</p> | <ul style="list-style-type: none"> ● Feed jam ● Additional paper tray is paper jam. |